

INCREASE THE EFFICACY OF WEED CONTROL FROM WHEAT CULTURE USING THE ASYMMETRICAL TWIN FLAT SPRAY AIR INJECTOR NOZZLES - IDTA

Alin Raoul Roman, Ovidiu Ranta, Călin Vac, Ioana Roman*

University of Agricultural Sciences and Veterinary Medicine of Cluj-Napoca, 3-5 Calea Mănăştur,
Cluj-Napoca, Cluj County, Romania

*Corresponding author. E-mail: ioana.roman@usamvcluj.ro

ABSTRACT

The paper work presents the results of a series of experimental research during two years, on the flow rate distribution of asymmetrical twin flat spray air injector nozzle (IDTA) in the wheat crop. In this respect, this paper aims to highlight the importance of using suitable nozzle types, adequate pressure and spray height for an efficacy of phytosanitary treatment in field crops. The research contributes to the implementation in the experimental field of digital technologies monitoring weeds, by using advanced information technology solutions in agriculture, respectively use of mobile thermospectral cameras attached to drones with a high degree of independence and specific programs for processing. In order to make the phytosanitary treatments more efficient in wheat crop, under the climatic conditions of the Transylvanian Plain, it is recommended to use the IDTA asymmetric double jet nozzle with air injection, based on the performances obtained in an experimental field, due to the constructive solutions that give it a uniformly high sprayed flow. The action of this type of nozzle is characterized not only by reducing the density of the weeds identified, but also by eradicating three species (*Polygonum* spp., *Chenopodium album* and *Xanthium* spp.), out of the total of the seven identified. The results of studies performed in laboratory conditions and experimental fields, in order to use this type of nozzle, led to the largest spray coating surfaces, both at the level of leaf tissue and at soil surface level.

Keywords: phytosanitary treatment, spray rates, drone, weeds identification, weeds eradication.

Abbreviation: IDTA - asymmetrical twin flat spray air injector nozzle; IT - information technology; NIR - near infrared; ACS - agricultural crop survey; RGB - red, green and blue visible spectrum.

INTRODUCTION

Wheat is an important food crop and it is considered that its production accounts for more than 20% of the world's arable land (Liu et al., 2016). Phytosanitary treatments and fertilization ensure high productivity of wheat; nitrogen is considered an important factor for good grain quality. The goal of phytosanitary treatment is to put the necessary quantity of pesticides on the crop, to reduce the pest in order to improve agricultural production (Hassen et al., 2013). In opinion of Butts et al. (2019) the chemical weed control is an important "component of integrated weed management strategies because of its cost-effectiveness and rapid removal of crop pests". The economic and ecological importance of using spraying equipment with different types of nozzle, in

field crops, was revealed by the studies carried out by Roşu et al. (2017). The research made by Kaczmarek and Matysiak (2017) revealed the importance of the plant protection against weeds and the possibility of a reduction in herbicide doses using different pressures, high and performant nozzles without a significant decrease in effectiveness or yield reduction of the phytosanitary treatments. Also the studies conducted by Hlisnikovsky et al. (2016), Panayotova et al. (2017) and Madjar et al. (2018) showed correlations between fertilization and quality parameters for wheat.

The pedo-climate and ecological frame from the Transylvanian Depression is given by the existence of the interaction of a great number of factors, of which two are very important for the agroecosystem (Rusu et al., 2017).

Using anti drift nozzles in spray application process in boom sprayers is an effective way to reduce the drift of the process (Hoffmann et al., 2010; Gil et al., 2014). Nozzles with low drift were used to investigate the control of weeds using contact herbicides (Jensen et al., 2001). Contiero et al. (2019) evaluated the influence and the effect of different types of nozzle used by phytosanitary treatments and relation between them and climatic condition or time of the application on weed control. In the last years, the testing of drift reduction technologies and the need to develop a testing program in this scope, have come to the interest of application research (Sayles, et al., 2006; Hoffmann et al., 2010; Contiero et al., 2016). The information about the direct drift resulting from the applications of phytosanitary treatment is few (Langkamp-Wedde et al., 2020). However, in some cases, farmers are still reticent to use different nozzle types despite their performance.

The objective of the present research aims to testing the capacity of the air injection asymmetric double jet spray nozzle - IDTA, in the control of weeds in wheat crop. For this purpose, an experimental protocol was developed to determine the functional effectiveness of this type of nozzle, for different pressures (3 bar and 6 bar) and different spray heights (30 cm, 50 cm and 65 cm).

MATERIAL AND METHODS

The research was conducted for two years and a half, on an area of 6000 m² cultivated with wheat, in the experimental field Gilău, in Cluj County. This experimental field is located on the first terrace of Someșul Mic River and has a slope of 5%.

In the present experiment a number of 9 variants were taken into account, in 3 repetitions, totalling 27 variants. Within each repetition a phytosanitary treatment scheme was applied during the vegetation period, with 1 ÷ 100 Dicopur concentration. The surface of an experimental variant is 60 m², with a length of 120 m and a width of 0.5 m. The degree of attack of the main wheat weeds was evaluated. Based on the data obtained,

correlations were established between their degree of attack and the effectiveness of the technological solutions adopted. Depending on the correlations obtained, series of measures have been proposed in order to optimize the application of the phytosanitary treatments to the studied crop.

The biological material was represented by Andrada wheat variety, which is part of the species *Triticum aestivum* (L.) ssp., *Vulgare* (Will.), *Host*, *MacKey*, the ferrugineum *Variety* (Korn.), having the red spike, the arista and the red grain. The weed species identified in the wheat culture were: *Agropyrum repens*, *Polygonum* spp., *Papaver rhoeas*, *Sonchus arvensis*, *Chenopodium album*, *Xanthium strumarium*, *Avena fatua* and so on.

It was used, for fertilization, 15:15:15 Complex NPK ternary mineral fertilizer, from Azomureș Ltd Company, at a dose of 150 kg/ha. The herbicide was based on Dicopur active substance, a hormonal systemic herbicide produced by Nufarm, in 1% concentration.

For carrying out the present research were used the EEP 600 and EEP 800 herbicide machines, (produced by Tehnofavorit Bontida - a local company), intended for the administration of herbicides, insects - fungicides and liquid fertilizers in field crops.

The characteristics of the asymmetrical twin flat spray air injector nozzle - IDTA (Figure 1) are as follows: front spray is 120 degrees angle and rear is 90 degrees angle; the vertical angle of the spray jet is 30 degrees for the front jet and 50 degrees angle for the rear jet; the volume of distribution of the substance is 60% for the front jet and 40% for the rear jet; plastic material (POM or PP), with ceramic type spray heads; the flow area of the nozzle is 01-08, a flow rate of 3 to 6 bar was used; the pressure range is from 1.5 to 8 bar. The research was carried out at a pressure of maximum 6 bar. The construction is compact block and has a length of 22 mm; spray with fine drops for the front jet and medium drops for the rear jet; it does not require a locking nut because it is included in the block body of the nozzle; it is a state-of-the-art nozzle with a small drift degree, ensuring a uniform dispersion in both front and rear.

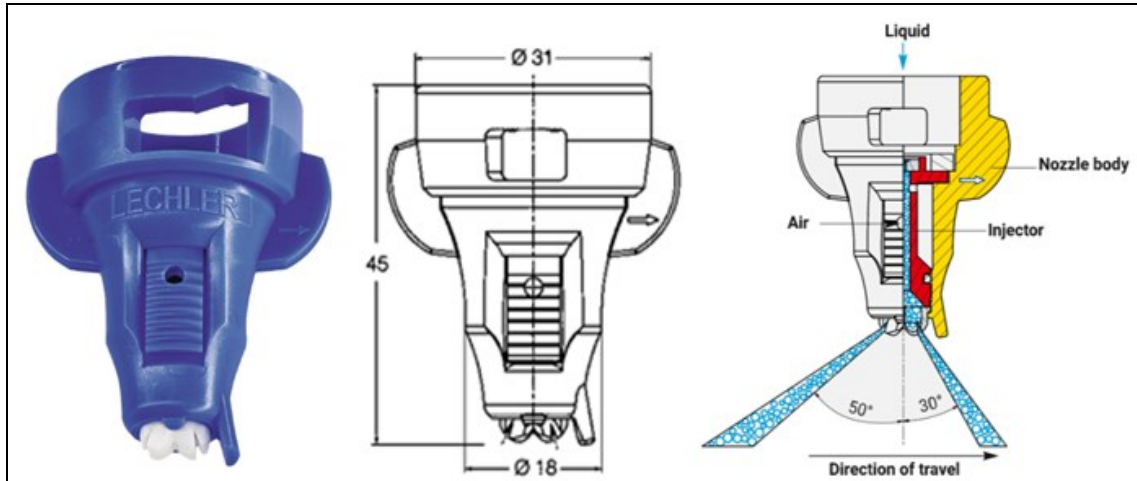

Figure 1. Asymmetrical twin flat spray air-injector nozzles IDTA (www.lechler.com)

Throughout the field performance of the phytosanitary treatments, the working speeds and the pressures established (speed of 5 km/h, and the pressure 3 bar respectively the speed of 7 km/h and the pressure of 6 bar) were respected initially to fulfil the prescribed liquid norm. A great attention was paid to the working heights of the splash ramps ($h = 30, 50$ and 65 cm), to ensure a uniform treatment.

In the process of detection and identification the weeds in the crop it was used a DJI Inspire 1 PRO drone. The camcorder resolution is 4K (4000 pixels x 3000 pixels) at 25 frames per second with a system that allows the filming angle to be changed through the 3-axis stabilizer, the camera resolution being 16 Mp. The camera was set to capture 25 frames per second in both infrared (RGB) and visible spectrum resulting in the orthophotoplan of the crop field. The scanning was done at an angle of 75% and laterally at an angle of 65%, resulting in the digital three-dimensional model. The database was created by 3D scanning, with a Vinyl scanner with accuracy of $6 \mu\text{m}$ and High Definition resolution (1280 x 720 pixels), for the weeds taken from the experimental field and the surrounding land. The ACS (Agricultural crop survey) program was used, having the role of processing the images taken by the thermal chamber by performing 5 filtrations in each RGB spectrum, respectively red, green, blue and 5 filtrations in the visual spectrum.

The mathematical and statistical methods were used; the cluster analysis from the “Multivariate Analysis” package was implemented in order to group the nozzle flow rates studied, with double asymmetric jet with IDTA air injection, depending on the dispersion gap. Thus, the cluster analysis was implemented in order to identify homogeneous groups, resulting from the grouping of the components, so as to minimize intra-group variation. The variables were selected in groups (clusters) so that should be as many similarities as possible between the components of a cluster, and as many differences as possible between the components of the different clusters. An important premise in performing this analysis is the selection of the distance between components, to which is added the selection of the algorithm with which the grouping will be performed and the grouping level.

The distance between the elements is measured using a series of algorithms conditioned by the nature of the variables. Thus, in the case of the present study, in which the variables are continuous, the Euclidean distance (the distance between the cluster centres) is calculated, according to the formula:

$$d(x, y) = \sqrt{\sum_{i=1}^n (x_i - y_i)^2}$$

Notes:

- $d(x, y)$: is the Euclidean distance;
- x_i, y_i : are the components of the clusters.

The graphical representation in the Cluster analysis, respectively the creation of the dendrogram, has the purpose of clearly highlighting the differences of the component groups. There must be small distances between the distant branches of the cluster and larger ones between the close ones.

Box-plot diagrams were used (for highlighting quantitative data models), cluster diagrams (dendrograms) and three-dimensional response surfaces from the “Graphics” option of the software package used, in order to graphically represent the entire set of flow media. IDTA nozzles were used for each 10 m dispersion gap, of the flow groups, depending on the similarities and the interdependencies between the spray rates of herbicides, weed biomass and their density relative to the square meter.

RESULTS AND DISCUSSION

By using the IDTA nozzle, in order to herbicide the wheat crop, our study highlighted specific features related to both

herbicide rates and the efficacy of herbicide in the experimental field.

As a result of processing with the support of the Agricultural Crop Survey program (ACS) of the images filmed by the thermal camera by performing 5 filtrations in each RGB spectrum respectively red, green, blue and 5 filtrations in the visual spectrum, it was possible to compare the results with the existing database. Using this method determined the average of weeds identified in their culture and their spatial positioning (Figure 2a-g).

As the first practical applications of the NIR spectroscopy were in the field of cereal property evaluation (Vlase and Duda-Semian, 2012), in the present research their applicability has been extended to determine the number of weeds in the experimental field. This was possible because NIR spectroscopy can determine the colour, water content, starch etc., in addition each plant species has a different absorption wavelength in IR (Figure 2a-g).

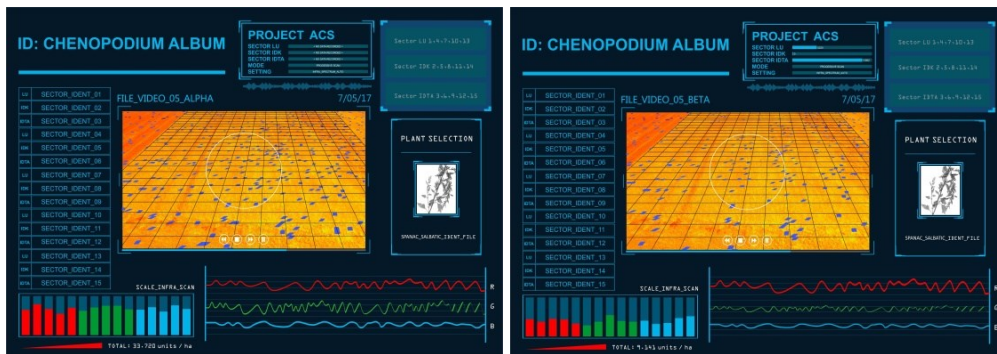

Figure 2a. *Chenopodium album* - wild spinach before and after herbicide

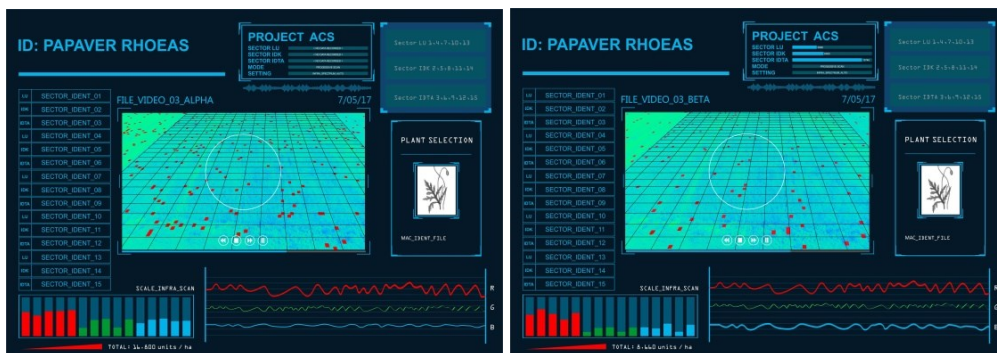

Figure 2b. *Papaver rhoeas* - red poppy before and after herbicide

ALIN RAOUL ROMAN ET AL.: INCREASE THE EFFICACY OF WEED CONTROL FROM WHEAT CULTURE USING THE ASYMMETRICAL TWIN FLAT SPRAY AIR INJECTOR NOZZLES - IDTA

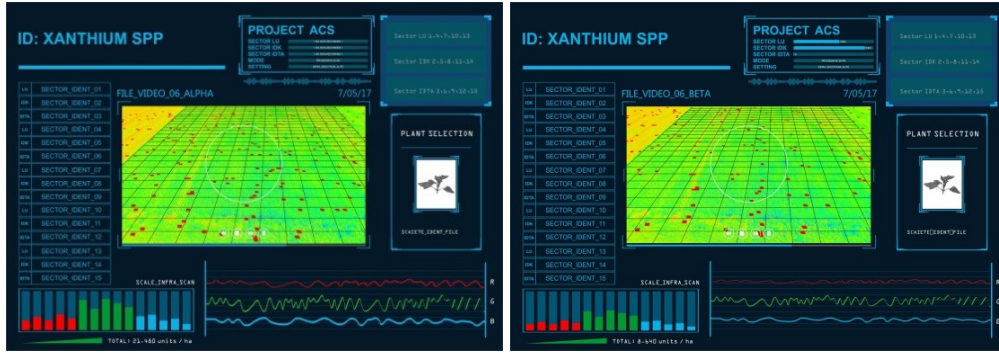

Figure 2c. *Xanthium spp.* - thistle before and after herbicide

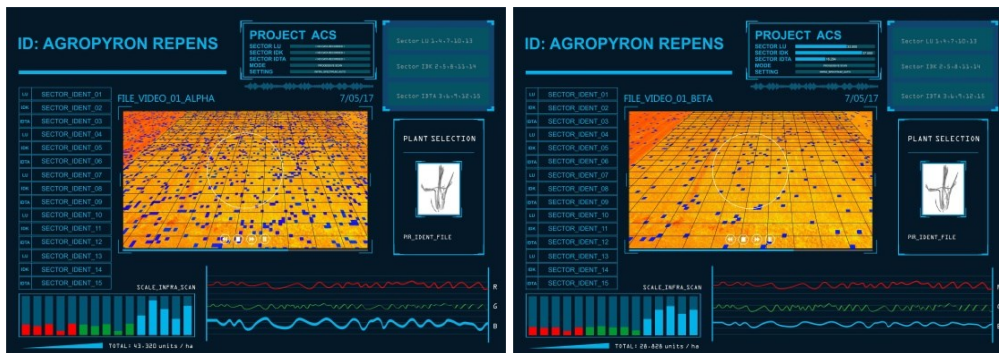

Figure 2d. *Agropyron repens* - couch grass before and after herbicide

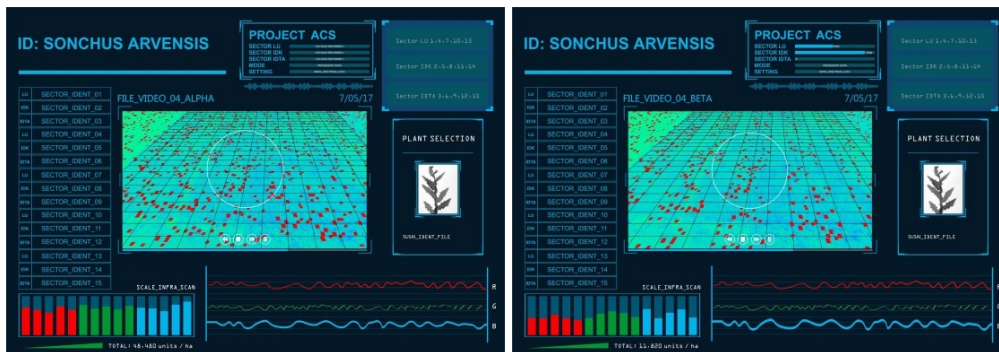

Figure 2e. *Sonchus arvensis* - sow thistle before and after herbicide

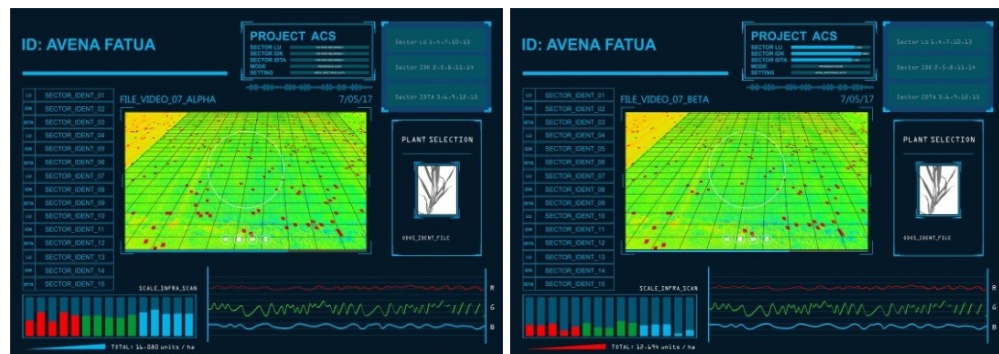

Figure 2f. *Avena fatua* - odos before and after herbicide

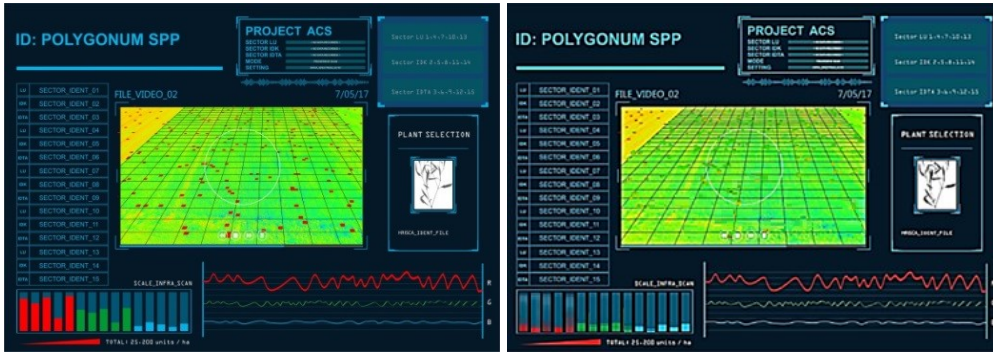

Figure 2g. *Polygonum* spp. - buckwheat before and after herbicide (after herbicidation *Polygonum* spp. was eliminated)

Figure 2a-g. Weeds distribution in field before and after treatment (author processing)

The absorption bands of the most common IR spectrum were around 1200 nm (NIR), as a result they were attributed to this wheat being the majority in culture. At the same time, they were removed from the measurements in order to identify only the weeds.

As a consequence, the interpretation of the spectrum was made by identifying the positions of the specific weeds bands. Weed detection in crops is important, for herbicide applications, this is accomplished by processing precision images based on sensors (Langner et al., 2006; Gitelson, 2004; Marchant et al., 2001). In precision agriculture, images from camera-based

sensors are commonly used for weed identification and crop line detection, either to specifically apply treatments or to guide vehicles. The role of precision in identifying and detecting weeds in culture is an important issue. Aspects related to the accuracy of identification and detection, the way in which the processing of images must be approached were also studied by Romeo et al. (2013), López-Granados (2011) and Montalvo et al. (2012).

When these nozzles were used, different spray rates were reported, depending on the spray distances considered from the reference point, in the range 10-500 cm, at different pressures and spray heights (Figure 3a-f).

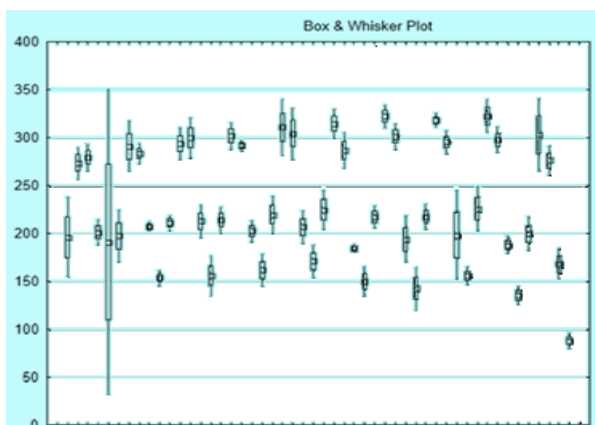

a) p = 3 bar, h = 30 cm

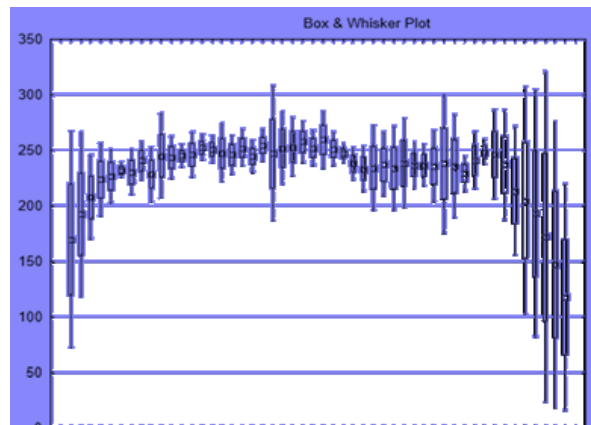

b) p = 6 bar, h = 30 cm

c) $p = 3$ bar, $h = 50$ cmd) $p = 6$ bar, $h = 50$ cme) $p = 3$ bar, $h = 65$ cmf) $p = 6$ bar, $h = 65$ cm

Figure 3a-f. The Box-plot diagrams for wheat herbicidation flow, with asymmetric double jet nozzle with air injection IDTA, for different dispersion pressures and heights

At a pressure of 3 bar and a height of 30 cm, spray rates have values in a very wide range, respectively between 150 l/h and 350 l/h, being characterized by very small dispersions. A very high dispersion of the spray rate was recorded in distance of 50 cm from the spray source, to the operating parameters of the IDTA nozzle, at the pressure of 3 bar and the spray height 30 cm (Figure 3a).

At the pressure of 6 bar and the height of 30 cm, in most cases, the flows were in a narrow range, 250-275 l/h. Mostly, the dispersions were reduced, except in the case of the dispersion rates of the IDTA asymmetric double jet nozzle with air injection, recorded at the shortest distances from the spray nozzle, respectively 30 cm and 40 cm on the one hand and at the greatest distances from the spray source, respectively 460-500 cm (Figure 3b).

Regarding the spray height of 50 cm and the pressure of 3 bar, most spray rates were summarized in the reduced range 200-240 l/h with moderate dispersions for almost all distances from the spray source (Figure 3c), in contrast to the values recorded at the same spray height, but at the pressure of 6 bar, which vary in a very wide range, respectively 200-550 l/h, and which were characterized by dispersions, mostly alternating between very small and moderate (Figure 3d).

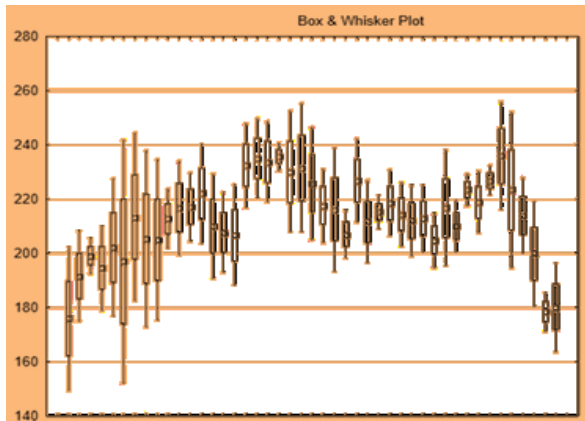
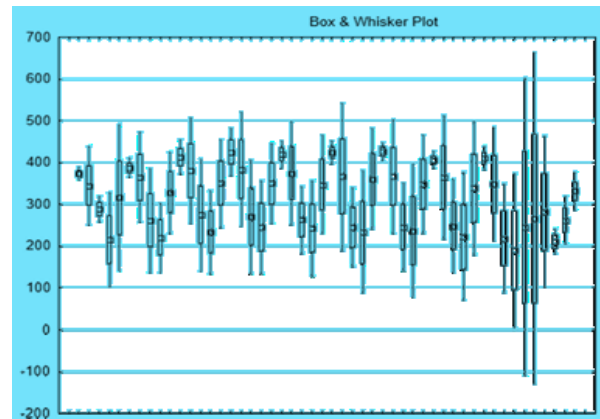
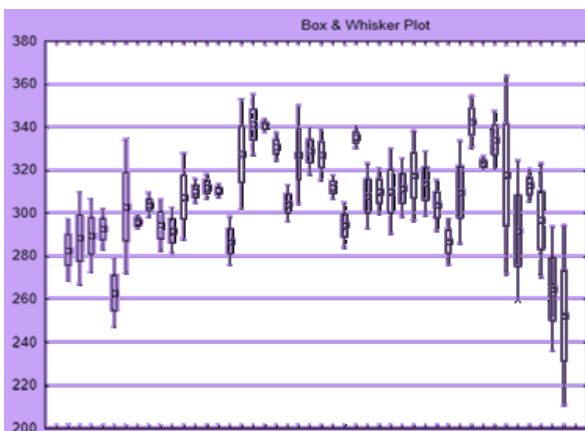
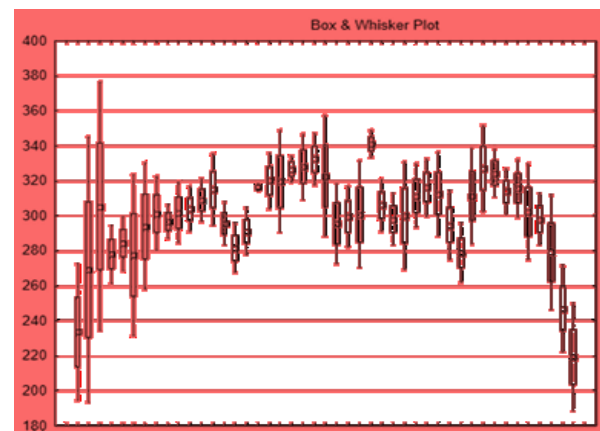
At the spray height of 65 cm and the pressure of 3 bar, the Box-Plot diagram shows spray rates in the range 280-340 l/h, with very low dispersions for most distances from the spray source (Figure 3e). In this case, high dispersion degrees are recorded only for the distances of 80 cm, 450 cm, 460 cm, 490 cm and 500 cm from the spray source (Figure 3e).

At the same spray height of 65 cm, but for the pressure of 6 bar, the most dispersion rates fall within the value range 260-340 l/h, being characterized by moderate dispersions for the flows recorded at most distances from the spray source, excepting those reported at distances of 40 cm and 50 cm from the spray source (Figure 3f).

Applying the cluster analysis, in order to study the IDTA nozzle flow rates, with which the herbicidation of wheat crop from the experimental field was realized, highlights different characteristics of the spray rates, depending on the spraying heights and heights of the herbicides (Figure 4a-f).

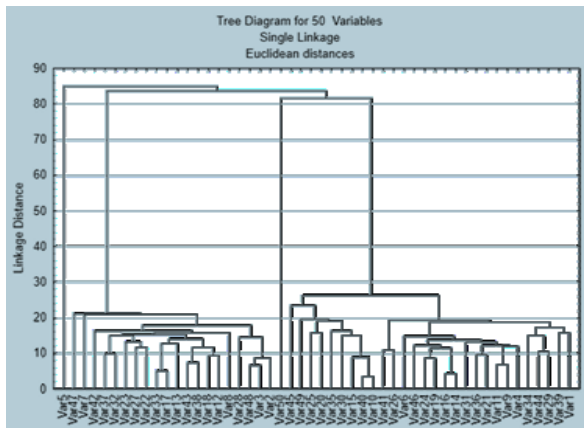

a) p = 3 bar, h = 30 cm

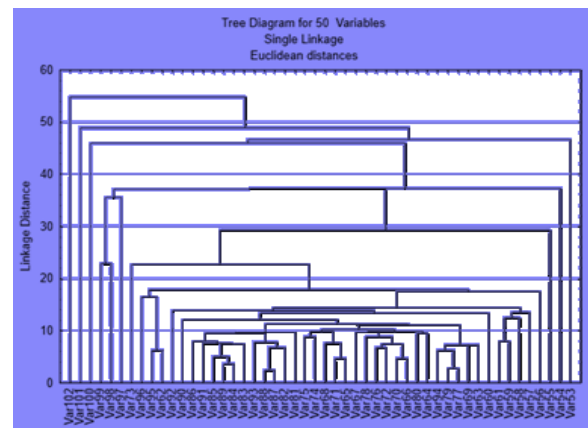

b) p = 6 bar, h = 30 cm

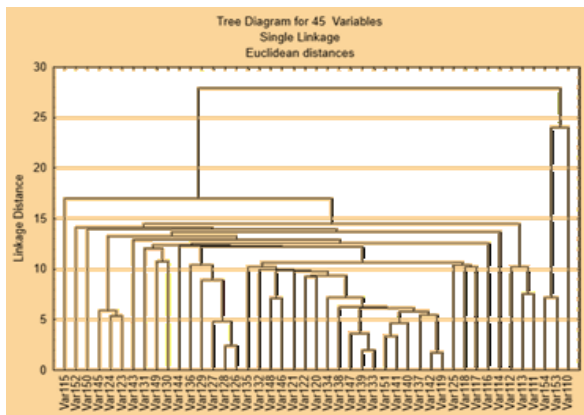

c) p = 3 bar, h = 50 cm

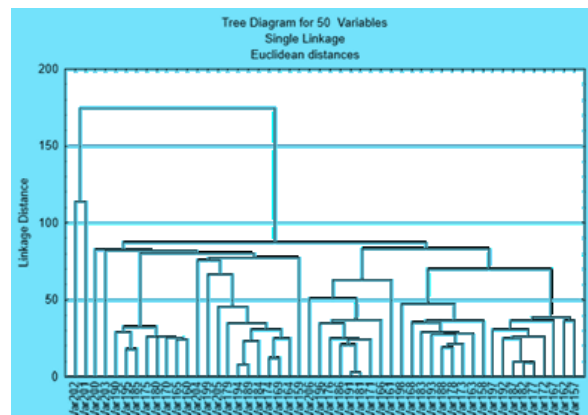

d) p = 6 bar, h = 50 cm

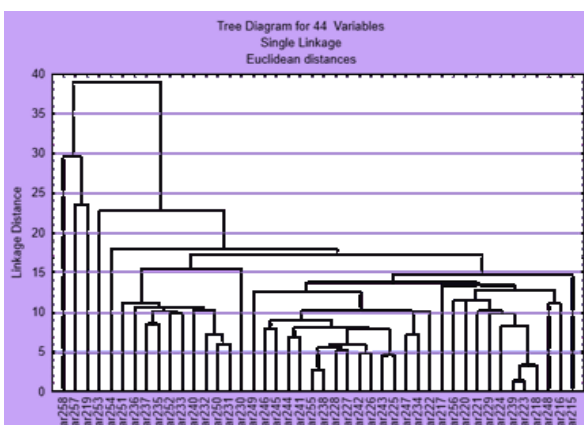

e) p = 3 bar, h = 65 cm

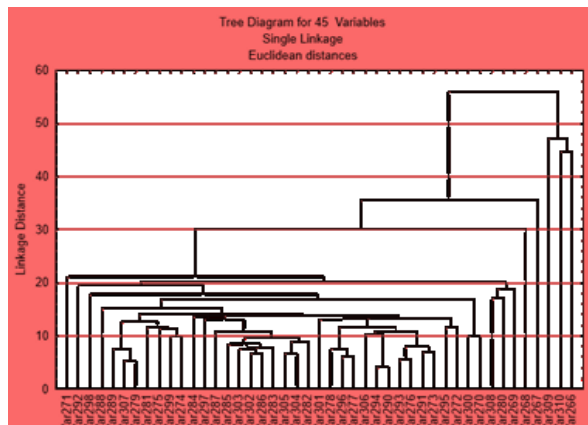

f) p = 6 bar, h = 65 cm

Figure 4a-f. The cluster analysis for wheat herbicidation flow, with multifunctional nozzle asymmetric double jet nozzle with air injection IDTA, for different dispersion pressures and heights

At the spray height of 30 cm and the pressure of 3 bar, two main clusters of herbicide spray rates were highlighted, the first one consisting of a single branch, corresponding to a moderate flow, but characterized by a high degree of dispersion, and the second one consisting, in turn, of two subdivisions, subdivided in turn (Figure 4a).

At the pressure of 6 bar and the spray height of 30 cm, two clusters were also highlighted, the first one consisting of a single branch, corresponding to a moderate flow, and the second one consisting of several subdivisions (Figure 4b).

For spray height of the herbicide equal to 50 cm, at the spray pressure of 3 bar, two clusters were highlighted, the first one consisting of two subdivisions, which in turn consist of a multitude of debits, and the second one consisting of two sub-clusters, of which one singular (Figure 4c).

At the same spraying height, respectively 50 cm, but at the pressure of 6 bar, the spray rates, of the nozzle with asymmetrical double jet with IDTA air injection, were grouped in two clusters, the first one consisting of two branches, and the second one being subdivided into two other sub-branches, each consisting of a multitude of subdivisions (Figure 4d).

Corresponding to the height of 65 cm, for the pressure of 3 bar, the spray rates of the herbicides were grouped into 2 clusters, the first one divided into two sub-clusters, one of which consisting of a single branch, and the second of two branches, and the second cluster consisting of several sub-clusters (Figure 4e).

At the pressure of 6 bar, two clusters were reported, the first one corresponding to a large number of subdivisions, and the second one, divided into two sub-clusters, both with branches corresponding to the other flows recorded at different distances from the spray source. The first sub-cluster was characterized by only one branch, and the second of 2 branches corresponding to the two related flows (Figure 4f).

CONCLUSIONS

As a result of the experiment carried out in the field for herbicide treatment in wheat, with the asymmetrical twin flat spray air injector nozzle - IDTA, for different dispersion pressures and heights, the presence of several particularities was emphasized.

Thus, as shown by the Box-Plot diagrams and the groups resulting from the Cluster analysis, a number of differences was highlighted, between the flow values and the uniformity of the dispersion degree related to the pressure and spray height.

Before applying herbicide, as already pointed out, seven species of weeds were identified in the experimental field, respectively: *Agropyrum repens*, *Polygonum* spp., *Papaver rhoeas*, *Sonchus arvensis*, *Chenopodium album*, *Xanthium* spp. and *Avena fatua*. In this case, the use of IDTA nozzle, after administration of herbicides, it was found to have been eradicated the largest number of weed species within the experimental device, respectively *Polygonum* spp., *Chenopodium album* and *Xanthium* spp., and the number of weeds belonging to the other species decreased, reaching various levels, depending on the technological conditions of herbicide administration, respectively the pressure and the height of dispersion.

The highest degree of uniformity is recorded when it was used asymmetric double jet with air injection nozzle of IDTA type, where the mean flows differ one from the others at the same significance threshold, at pulverization heights of 50 cm and 65 cm, respectively, where are reported the biggest values, whatever used pulverization pressure.

When choosing an effective herbicide solution, it is recommended to consider two main factors: spray technology, an important factor being the type of nozzle used, as well as the potential for weed loading of the crop.

The use of NIR scanning technology in the detection and analysis of wheat crops opens new horizons regarding the transfer of IT technology to agriculture and a multitude of

possible applications that lead to the increase of the efficiency and effectiveness of the phytosanitary treatments.

REFERENCES

- Butts, T.R., Samples, C.A., Franca, L.X., Dodds, D.M., Reynolds, D.B., Adams, J.W., Zollinger, R.K., Howatt, K.A., Fritz, B.K., Clint Hoffmann, W., Luck, J.D., Kruger, G.R., 2019. *Droplet size impact on efficacy of a Dicamba-plus-Glyphosate mixture*. Weed Technology, 33(1): 66-74.
DOI: 10.1017/wet.2018.118
- Contiero, R.L., Biffe, D.F., Constantin, J., de Oliveira Jr., R.S., Pereira Braz, G.B., Lucio, F.R., Schleier, J.J., 2016. *Effects of nozzle types and 2,4-D formulations on spray deposition*. Journal of Environmental Science and Health, Part B, Vol. 51, Issue 12: 888-893.
- Contiero, R.L., Rios, F., Biffe, D.F., Pereira Braz, G.B., Constantin, J., de Oliveira Jr., R.S., Gheno, E.A., Lucio, F.R., 2019. *Effect of day time climatic conditions associated with different 2,4-D formulations on spray deposition and weed control*. Journal of Environmental Science and Health, Part B, 54(10): 803-809.
- Gil, E., Balsari, P., Gallart, M., Calveras, J.L., Marucco, P., Andersen, P.G., Fabregas, X., Casamada, J.L., 2014. *Determination of Drift Potential Value (DPV) for different flat fan nozzles using a horizontal drift test bench*. Crop Protection, 56: 58-68.
DOI: 10.1016/j.cropro.2013.10.018
- Gitelson, A.A., 2004. *Wide dynamic range vegetation index for remote quantification of biophysical characteristics of vegetation*. J. Plant Physiol., 161: 165-173.
- Hassen, N.S., Sidik, N.A.C., Sheriff, J.M., 2013. *Effect of nozzle type, angle and pressure on spray volumetric distribution of broadcasting and banding application*. Journal of Mechanical Engineering Research, 5(4): 76-81.
<https://doi.org/10.5897/JMER2013.0272>
- Hlisnikovsky, L., Kunzova, E., Mensik, L., 2016. *Winter wheat: results of long term fertilizer experiment in Prague-Ruzyne over the last 60 years*. Plant Soil Environment, 62(3): 105-113.
- Hoffmann, W.C., Fritz, B.K., Thornburg, J.W., Bagley, W.E., Birchfield, N.B., Ellenberger, J., 2010. *Spray drift reduction evaluations of spray nozzles using a standardized testing protocol*. Journal of ASTM International, Vol. 7, no. 8, Paper ID: JAI102820.
- Jensen, P.K., Jorgensen, L.N., Kirknel, E., 2001. *Biological efficacy of herbicides and fungicides applied with low-drift and twin-fluid nozzles*. Crop Protection, Elsevier, 20: 57-64.
- Kaczmarek, S. and Matysiak, K., 2017. *Wheat cultivars, their mixtures and reduced herbicide doses as a practical solution in integrated weed management*. Romanian Agricultural Research, 34: 1-8.
- Langkamp-Wedde, T., Rautmann, D., von Hörsten, D., Wegener, J.K., 2020. *Comparison of the drift potential of two application methods for the control of oak processionary moths with biocidal products in an oak avenue*. The Science of the Total Environment, 704, PMID: 135313.
DOI: 10.1016/j.scitotenv.2019.135313
- Langner, H., Bottger, H., Schmidt, H., 2006. *A special vegetation index for the weed detection in sensor based precision agriculture*. Environmental Monitoring and Assessment, 117: 505-518.
- Liu, B., Asseng, S., Liu, L., Tang, L., Cao, W., Zhu, Y., 2016. *Testing the responses of four wheat crop models to heat stress at anthesis and grain filling*. Glob Change Biol., 22: 1890-1903.
- López-Granados, F., 2011. *Weed detection for site-specific weed management: Mapping and real-time approaches*. Weed Res., 51: 1-11.
- Madjar, R.M., Scăteanu, G.V., Anton, A., 2018. *Improve of grain yield and quality of winter wheat by nitrogen inputs*. Scientific Papers: 310.
- Marchant, J.A., Andersen, H.J., Onyango, C.M., 2001. *Evaluation of an imaging sensor for detecting vegetation using different waveband combinations*. Comp. Electr. Agric., 32: 101-117.
- Montalvo, M., Pajares, G., Guerrero, J.M., Romeo, J., Guijarro, M., Ribeiro, A., Ruz, J.J., de la Cruz, J.M., 2012. *Automatic detection of crop rows in maize fields with high weeds pressure*. Exp. Syst. Appl., 39: 11889-11897.
- Panayotova, G., Kostadinova, S., Valkova, N., 2017. *Grain quality of durum wheat as affected by phosphorus and combined nitrogen-phosphorus fertilization*. Scientific Papers, Vol. LX, Series A, Agronomy: 356-363.
- Romeo, J., Guerrero, J.M., Montalvo, M., Emmi, L., Guijarro, M., Gonzalez-de-Santos, P., Gonzalo, P., 2013. *Camera sensor arrangement for crop/weed detection accuracy in agronomic images*. Sensors, 13: 4348-4366.
- Roșu, N.M., Căsandroi, T., Cârdei, P., Matache, M.G., Pruteanu, A., Găgeanu, I., Cujbescu, D., Ungureanu, N., Cristea, M., 2017. *Experimental researches on the flow rate distribution of field spraying machine nozzles*. In: International Symposium, ISB-INMA TEH' 2017, Agricultural and mechanical engineering, Bucharest, Romania, 26-28 October 2017, INMA Bucharest: 969-974.
- Rusu, T., Coste, C.L., Moraru, P.I., Szajdak, L.W., Pop, A.I., Duda, B.M., 2017. *Impact of climate change on 62 agro-climatic indicators and agricultural lands in the Transylvanian Plain*

ALIN RAOUL ROMAN ET AL.: INCREASE THE EFFICACY OF WEED CONTROL FROM WHEAT CULTURE USING THE ASYMMETRICAL TWIN FLAT SPRAY AIR INJECTOR NOZZLES - IDTA

- between 2008-2014*. Carpathian Journal of Earth and Environmental Sciences, 12(1): 23-34.
- Sayles, G., Birchfield, N., Ellenberger, J., 2006. *US EPA's research proposal for encouraging the use of spray drift reduction technologies*. Proceedings of the International conference on pesticide application for drift management, Waikaloa, HI, Washington State University: 204-209. <http://pep.wsu.edu/drift04/proceedings.html>
- Vlase, C. and Duda-Semian, C., 2012. *Metode fizico-chimice de analiză a substanțelor cu activitate biologică*. Univ. Al. I. Cuza, Iași. <http://bit.ly/2Hgm6H>
- *** Asymmetrical twin flat spray air-injector nozzles IDTA. <https://www.lechler.com/de-en/products/product-range/agriculture/nozzles-for-broadcast-spraying/idta/>, accessed 10.07.2020.